

Copyright© Chauvin Arnoux®, Inc. d.b.a. AEMC® Instruments. All rights reserved.

No part of this documentation may be reproduced in any form or by any means (including electronic storage and retrieval or translation into any other language) without prior agreement and written consent from Chauvin Arnoux®, Inc., as governed by United States and International copyright laws.

Chauvin Arnoux®, Inc. d.b.a. AEMC® Instruments
15 Faraday Drive • Dover, NH 03820 USA
Tel: (800) 945-2362 or (603) 749-6434 • Fax: (603) 742-2346

This documentation is provided **as is**, without warranty of any kind, express, implied, or otherwise. Chauvin Arnoux®, Inc. has made every reasonable effort to ensure that this documentation is accurate; but does not warrant the accuracy or completeness of the text, graphics, or other information contained in this documentation. Chauvin Arnoux®, Inc. shall not be liable for any damages, special, indirect, incidental, or inconsequential; including (but not limited to) physical, emotional or monetary damages due to lost revenues or lost profits that may result from the use of this documentation, whether or not the user of the documentation has been advised of the possibility of such damages.

Statement of Compliance

Chauvin Arnoux[®], Inc. d.b.a. AEMC[®] Instruments certifies that this instrument has been calibrated using standards and instruments traceable to international standards.

We guarantee that at the time of shipping your instrument has met the instrument's published specifications.

An NIST traceable certificate may be requested at the time of purchase, or obtained by returning the instrument to our repair and calibration facility, for a nominal charge.

The recommended calibration interval for this instrument is 12 months and begins on the date of receipt by the customer. For recalibration, please use our calibration services. Refer to our repair and calibration section at www.aemc.com/calibration.

Serial #: _____

Catalog #: 2150.20

Model #: OX 5022B

Please fill in the appropriate date as indicated:

Date Received: _____

Date Calibration Due: _____



Chauvin Arnoux[®], Inc.
d.b.a AEMC[®] Instruments
www.aemc.com

PRODUCT PACKAGING (2150.20)



Handscope Oscilloscope
Model OX 5022B
Cat. #2150.20



(2) Adapter Banana-F
BNC-M
Cat. #2118.46



(1) Probe 10:1 600 V
BNC-M
Cat. #5000.50



(2) Sets of two color-coded leads
and clips (5 ft)
(Note: Color of replacement leads
are solid red & solid black)



(2) Red Test Probe
Cat. #5000.98
(2) Black Test Probe
Cat. #5000.97



Metrix Carrying
Pouch



OX 5022B / OX 5042B
Cable - Replacement USB
Charging Cable
Cat. #5100.17



(1) USB Cable + Driver
Cat. #2135.41



*(1) USB Wall Plug,
5 V, 2 A

Also Included:

- (1) Test Report
- (1) European 220 V Wall Plug
- (1) Battery Information Sheet
- (6) 1.2 V NiMH rechargeable batteries 2700 mA·h

*Replacement 5 V, 2 A USB power adapters are commercially available.











(1) USB Drive
SX-METRO Software
&
OX 5022B / OX 5042B
User Manual

Thank you for purchasing an AEMC® Instruments **Portable Oscilloscope Model OX 5022B**.

For the best results from your instrument and for your safety, you must read the enclosed operating instructions carefully and comply with the precautions for use. Only qualified and trained operators should use this product.

Symbols and Definitions

	Signifies that the instrument is protected by double or reinforced insulation
	CAUTION - Risk of Danger! Indicates a WARNING . Whenever this symbol is present, the operator must refer to the user manual before operation
	Indicates a risk of electric shock. The voltage at the parts marked with this symbol may be dangerous
	Indicates important information to acknowledge
	This product complies with the Low Voltage & Electromagnetic Compatibility European directives (73/23/CEE & 89/336/CEE)
	Ground/Earth
	The product has been declared recyclable
	In the European Union, this product is subject to a separate collection system for recycling electrical and electronic components in accordance with directive WEEE 2012/19/EU

Definition of Measurement Categories (CAT)

- CAT IV:** Corresponds to measurements performed at the primary electrical supply (< 1000 V).
Example: primary overcurrent protection devices, ripple control units, and meters.
- CAT III:** Corresponds to measurements performed in the building installation at the distribution level.
Example: hardwired equipment in fixed installation and circuit breakers.
- CAT II:** Corresponds to measurements performed on circuits directly connected to the electrical distribution system.
Example: measurements on household appliances and portable tools.

Precautions For Use

The operator and/or the responsible authority must carefully read and completely understand the precautions before use. If you use this instrument in an unspecified manner, the protection it ensures can be compromised, thus putting you in danger.

- This instrument is designed for use:
 - indoors
 - in a level 2 pollution environment
 - at an altitude below 2000 m
 - at a temperature between 0 °C and 40 °C
 - with a relative humidity of less than 80 % up to 35 °C
- The safety of all systems, including the instrument, is the responsibility of the operator.
- It can be used for measurements on 600 V CAT III circuits, relative to the ground/earth.
- Before each use, check the condition of the insulation on the cables, boxes, sensors and accessories. Any element on which the insulation is damaged (even partially) must be taken out of service for repair or disposal.
- Respect the environmental and storage conditions.
- The external power supply must be connected to the instrument and to the network (98 to 264) V_{AC}.
- The power supply to the instrument is fitted with an automatically resettable electrical protection after disappearance of the fault.
- As a safety measure, only use factory supplied parts and accessories.
- It is advised to use individual safety protection whenever the environmental situation in which the instrument is used requires protection.
- When handling the sensors or test probes, do not place your fingers beyond the physical guard.
- If the battery housing cover is absent, damaged or incorrectly positioned, the instrument must not be used other than to adjust the sensors.

Power Supply

The oscilloscope is supplied with one external power supply and set of (6) 1.2 V NiMH rechargeable batteries 2700 mA·h.

When the supplied wall plug is connected from the instrument to an external power source, battery power is not needed. The batteries are only used when there is no external power supply available.

Before the first use, start by fully charging the battery.



NOTE: The batteries automatically begin charging when the Oscilloscope is powered off, but connected to an external power supply.

When the batteries are charging, the Battery Charge LED on the front panel will turn on steady.

The LED will blink in the following situations:

- pre-charge of very low batteries
- temperature is too low or too high
- batteries are damaged

When the charge is complete, the LED will turn off.

If the batteries need to be replaced, they must be replaced with NIMH rechargeable batteries. Battery charge life is guaranteed for same-capacity batteries (in mA·h) as those shipped with the oscilloscope.

To remove the battery cover, use a coin to turn the slot on the back of the unit counter-clockwise.

Description

The Handscope Oscilloscope Model OX 5022B combines three instruments into one:

- 20 MHz oscilloscope
- Independent 8000 ct multimeter with power measurements
- Built-in harmonic analyzer out to the 31st harmonic (fundamental between 20 Hz and 450 Hz)

The instrument operates at a constant acquisition depth of 2500 points.

An LCD TFT screen is used to view the applied signals along with all the setting parameters.

The main command functions are accessible using the buttons on the front panel.

A graphic interface is used to:

- adjust the parameters related to the selected button
- navigate using a horizontal main menu showing the current settings and vertical sub-menus

Channel Isolation

The two oscilloscope input channels are isolated from each other and from the ground/earth and the main power supply block. This isolation is provided by double or reinforced insulation, in compliance with the safety standards IEC 61010-1 and IEC 61010-2-030.

This makes it possible to make measurements on installations or systems connected to the electricity supply network for voltages of up to 600 V in CAT III. The common mode authorized between the two channels is 600 V in CAT III. Thus the operator, the test systems and the environment are completely protected at all times.

Any voltage (even dangerous) on one channel will not be present on the other channel. The low points of the inputs are completely insulated, so there is no possibility of the low points looping (which can be dangerous and highly destructive).



NOTE: The use of accessories with a voltage and/or category lower than 600 V CAT III reduces the operating range to the lower voltages and/or categories.



The oscilloscope is rated 600 V CAT III; at least 600 V CAT III accessories must be used.

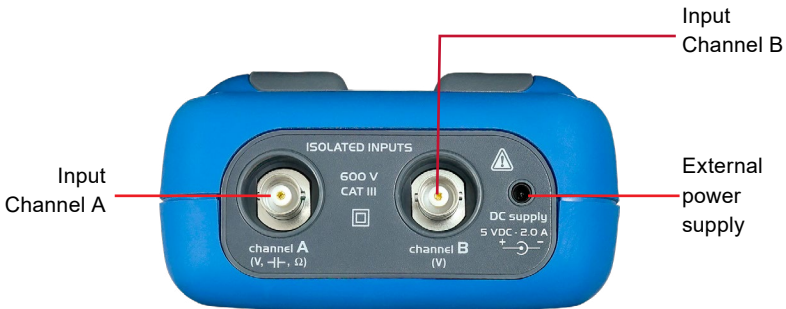



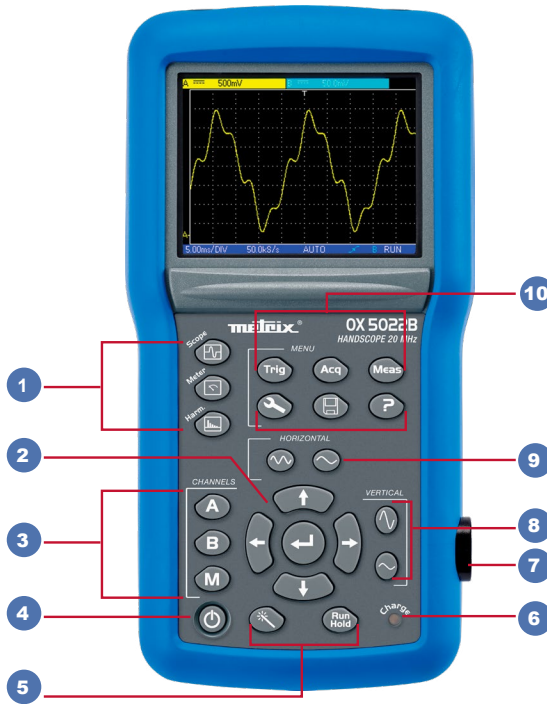



Measurement Terminals



Control Features



Item	Button	Description
1		<p>OPERATING MODE BUTTONS</p> <p>Press these buttons to select the desired operating mode:</p> <ul style="list-style-type: none"> ■ Oscilloscope ■ Multimeter ■ Harmonic analyzer
2		<p>NAVIGATION BUTTONS</p> <p>Use these navigation buttons to the menus and dialog boxes:</p> <p>VERTICAL</p> <ul style="list-style-type: none"> ■ Vertical movement and automatic selection in the secondary menus ■ Adjustment of values in the main menus ■ Vertical movement in a dialog box <p>HORIZONTAL</p> <ul style="list-style-type: none"> ■ Horizontal movement through the main menus ■ Adjustment of values in the secondary menus ■ Horizontal movement in a dialog box <p>ENTER</p> <ul style="list-style-type: none"> ■ Opens a dialog box from a main menu or a secondary menu ■ Validation of the items in a dialog box

Item	Button	Description
3		<p>CHANNEL A, B</p> <ul style="list-style-type: none"> A single press selects channel A (or B) and shows the corresponding menu Pressing twice deselects the channel <p>MATH/MEMORY BUTTONS</p> <ul style="list-style-type: none"> A single press selects channel M (Math) and shows the corresponding menu Pressing twice deselects the channel <p>NOTE: For the M (memory) channel, pressing twice invalidates the channel. Pressing once again selects the Math channel, the memory is lost and must be reloaded.</p>
4		<p>ON/OFF BUTTON</p> <ul style="list-style-type: none"> The instrument is turned ON by a short press on this button. It is turned OFF by a long press (a message about the shutdown will appear and a beep will sound).
5		<p>FUNCTION BUTTONS</p> <p>Auto Set: Performs an automatic adjustment on channels A and B. The success of each vertical autoset conditions the activation of the channel.</p> <p>Run Hold: Starts or stops an acquisition.</p>
6		<p>CHARGE STATUS</p> <ul style="list-style-type: none"> Battery Charge LED
7		<p>OPTICAL COMMUNICATOR</p> <ul style="list-style-type: none"> Provides the communication between the oscilloscope and a PC
8		<p>SENSITIVITY BUTTONS</p> <ul style="list-style-type: none"> Decreases the vertical sensitivity of the last selected channel down to 5 mV Increases the vertical sensitivity of the last selected channel up to 200 V <p>NOTE: For the M channel, the “sensitivity” buttons vary the amplitude factor but only if a math channel is validated.</p>
9		<p>TIME BASE BUTTONS</p> <ul style="list-style-type: none"> Increases the time base for acquisition up to 200 s Decreases the time base for acquisition down to 25 ns
10		<p>MENU BUTTONS</p> <ul style="list-style-type: none"> Displays the main Trigger menu Displays the main Tools menu Displays the main Acquisition menu Displays the main Memory menu Displays the main Measurement/Cursor menu Displays the Help window

Use of the 10:1 Probes

Distribution of stray capacitance:

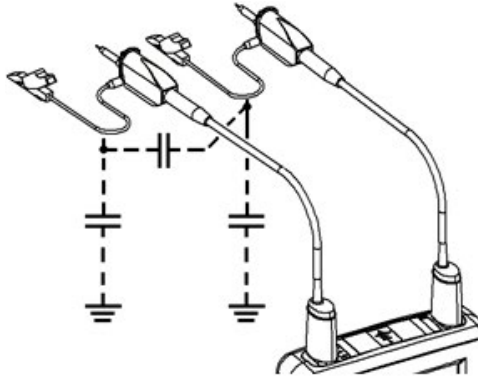

Considering the stray capacitances, make sure to correctly connect the reference conductors for each probe. The conductors should preferably be connected to the cold points to avoid the transmission of noise by the stray capacitance between modes.

The noise of the digital ground (earth) is sent to the analog input by stray capacitance.

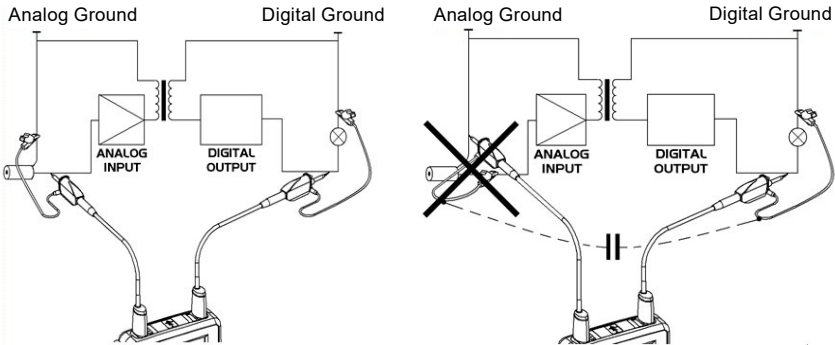

NOTE: To prevent electric shocks or possible fires, never use accessories on which the casing is accessible if it has a voltage of $>30 V_{RMS}$ compared to the ground.

10:1 Probe Calibration

For the best response, you must adjust the probe's low-frequency compensation.



NOTE: To carry out this adjustment, **the two channels of your oscilloscope** must be disconnected from the measured circuits before opening the battery housing cover.

The calibration output (3 V_{pp}, 1 kHz) for the probe is under the battery cover.

- To remove the battery cover, use a coin to turn the slot on the back of the unit counter-clockwise



Connect the probe to be adjusted to the calibration output under the battery housing cover, as shown to the left.

- Select the DC coupling for the channel connected to the probe
- Run an Autoset  to carry out pre-setting
- Adjust the sensitivity and vertical offset of the channel so that the signal fills the screen
- Adjust the time base to 200 μs to view a signal period on the screen

Turn the BNC base of the probe in to access the probe adjustment screw:

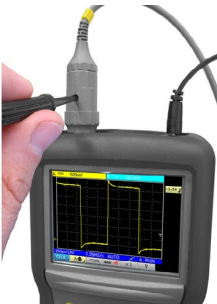

In this example, the probe is overcompensated, so an overshoot occurs.

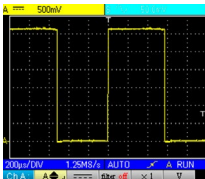

Turn the screw in either direction until the signal is horizontal and looks like the screen to the left. Your probe is now calibrated.

Turn the BNC base again to close access to the adjustment screw and replace the battery cover.

Remote Programming

The oscilloscope can be programmed remotely from a computer using the SX-METRO software. This software is located on the USB Drive supplied with your instrument. This software is used to:

- Configure the instrument
- Perform measurements and retrieve the results
- Transfer files (traces, configuration, screenshots, etc.)

To communicate between the instrument and the computer:

1. Connect the USB end of the cable to one of the PC's USB ports (if necessary install the driver shipped with the cable).
2. Connect the optical connector to the oscilloscope, after first powering it up.
3. Open SX-METRO; select USB communications and wait for communication to be established (in the event of a problem, refer to the SX-METRO software instructions).

Repair and Calibration

To ensure that your instrument meets factory specifications, we recommend that it be sent back to our factory Service Center at one-year intervals for recalibration or as required by other standards or internal procedures.

For instrument repair and calibration:

You must contact our Service Center for a Customer Service Authorization Number (CSA#). Send an email to repair@aemc.com requesting a CSA#, you will be provided a CSA Form and other required paperwork along with the next steps to complete the request. Then return the instrument along with the signed CSA Form. This will ensure that when your instrument arrives, it will be tracked and processed promptly. Please write the CSA# on the outside of the shipping container. If the instrument is returned for calibration, we need to know if you want a standard calibration or a calibration traceable to N.I.S.T. (includes calibration certificate plus recorded calibration data).

Ship To: Chauvin Arnoux®, Inc. d.b.a. AEMC® Instruments
15 Faraday Drive • Dover, NH 03820 USA
Phone: (800) 945-2362 (Ext. 360) / (603) 749-6434 (Ext. 360)
Fax: (603) 742-2346
E-mail: repair@aemc.com

(Or contact your authorized distributor.)

Contact us for the costs for repair, standard calibration, and calibration traceable to N.I.S.T.



NOTE: You must obtain a CSA# before returning any instrument.

Technical Assistance

If you are experiencing any technical problems or require any assistance with the proper operation or application of your instrument, please call, e-mail or fax our technical support team:

Chauvin Arnoux®, Inc. d.b.a. AEMC® Instruments

Phone: (800) 343-1391 (Ext. 351)

Fax: (603) 742-2346

E-mail: techsupport@aemc.com
www.aemc.com

Limited Warranty

The instrument is warranted to the owner for a period of three years from the date of original purchase against defects in manufacture. This limited warranty is given by AEMC® Instruments, not by the distributor from whom it was purchased. This warranty is void if the unit has been tampered with, abused, or if the defect is related to service not performed by AEMC® Instruments.

Full warranty coverage and product registration is available on our website at www.aemc.com/warranty.html

Please print the online Warranty Coverage Information for your records.

What AEMC® Instruments will do:

If a malfunction occurs within the warranty period, you may return the instrument to us for repair, provided we have your warranty registration information on file or a proof of purchase. AEMC® Instruments will repair or replace the faulty material at our discretion.

REGISTER ONLINE AT: www.aemc.com/warranty.html

Warranty Repairs

What you must do to return an Instrument for Warranty Repair:

First, send an email to repair@aemc.com requesting a Customer Service Authorization Number (CSA#) from our Service Department. You will be provided a CSA Form and other required paperwork along with the next steps to complete the request. Then return the instrument along with the signed CSA Form. Please write the CSA# on the outside of the shipping container. Return the instrument, postage or shipment pre-paid to:

Chauvin Arnoux®, Inc. d.b.a. AEMC® Instruments
15 Faraday Drive, Dover, NH 03820 USA
Phone: (800) 945-2362 (Ext. 360) / (603) 749-6434 (Ext. 360)
Fax: (603) 742-2346
E-mail: repair@aemc.com

Caution: To protect yourself against in-transit loss, we recommend that you insure your returned material.



NOTE: You must obtain a CSA# before returning any instrument.



10/23
99-MAN 100597 v02

AEMC[®] Instruments
15 Faraday Drive • Dover, NH 03820 USA
Phone: +1 (603) 749-6434 • +1 (800) 343-1391 • Fax: +1 (603) 742-2346
www.aemc.com
